



# **COLOUR TELEVISION**

# **INSTRUCTIONS**

Thank you for buying this JVC colour television.  
To make sure you understand how to use your new TV, please read this manual thoroughly before you begin.

- AV-21V311**
- AV-21V511**
- AV-21V531**
- AV-29V311**
- AV-29V511**
- AV-29V531**



## **Contents**

<b>Safety precautions</b>	<b>2</b>
<b>Preparation</b>	<b>3</b>
1 Confirm which remote control you have ..	3
2 Insert the batteries into the remote control ..	3
3 Connecting the aerial and VCR .....	4
4 Connecting other devices .....	5
5 Connect the power cord to the AC outlet .....	5
6 SETUP TOUR .....	6
<b>Basic operation</b>	<b>7</b>
<b>Remote control buttons and functions</b>	<b>8</b>
MUTING button .....	8
BASS button .....	8
SOUND SYSTEM button .....	8
COLOUR SYSTEM button .....	8
DISPLAY button .....	8
CINEMA SURROUND button .....	9
ECO SENSOR button .....	9
button .....	10
PICTURE MODE button .....	10
I/II button .....	10
OFF TIMER button .....	10
CHANNEL SCAN button .....	11
FAVORITE CH button .....	11
RETURN + button .....	11
<b>Using the TV's menus</b>	<b>12</b>
Basic operation .....	12
INPUT .....	13
PICTURE TILT .....	13
VNR .....	13
COMPRESS (16:9) .....	13
AUTO SHUTOFF .....	14
CHILD LOCK .....	14
BLUE BACK .....	14
VIDEO-2 SET .....	15
LANGUAGE .....	15
AUTO CH PRESET .....	15
MANUAL CH PRESET .....	16
SKIP .....	17
SETUP TOUR .....	17
Picture Adjustments .....	17
Sound Adjustments .....	17
AI VOLUME .....	18
SUPER BASS .....	18
FAVORITE CH SETTING .....	18
VIDEO SETTING .....	19
AI ECO SENSOR .....	19
AI ECO DISPLAY .....	19
<b>Attaching the Twin Port Bass Blaster Unit</b>	<b>20</b>
<b>TV buttons and parts</b>	<b>21</b>
<b>Using the buttons on the TV</b>	<b>22</b>
<b>Troubleshooting</b>	<b>23</b>
<b>Specifications</b>	<b>24</b>



GGT0015-001A-H  
0803-NIC-JMT

# Safety precautions

---

## WARNING

**TO PREVENT FIRE OR SHOCK HAZARD, DO NOT EXPOSE THIS APPLIANCE TO RAIN OR MOISTURE.**

## CAUTION

TO ENSURE PERSONAL SAFETY, OBSERVE THE FOLLOWING RULES REGARDING THE USE OF THIS TV.

- Operate only from the power source specified on the TV.
- Avoid damaging the power cord and main plug. When you unplug the TV, pull it out by the main plug. Do not pull on the power cord.
- Never block or cover the cabinet opening for ventilation. Never install the TV where good ventilation is unattainable. When installing this TV, leave spaces for ventilation around the TV more than the minimum distances shown in the diagram.
- Do not allow objects or liquid into the cabinet openings.
- In the event of a fault, unplug the TV and bring to JVC service centre. Do not attempt to repair it by yourself or remove the rear cover.
- The surface of the TV screen is easily damaged. Be very careful with it when handling the TV. Should the TV screen become soiled, wipe it with a soft dry cloth. Never rub it forcefully. Never use any cleaner or detergent on it.
- When you don't use this TV for a long period of time, be sure to disconnect the power plug from the AC outlet.
- The apparatus shall not be exposed to dripping or splashing and that no objects filled with liquids, such as vases, shall be placed on the apparatus.

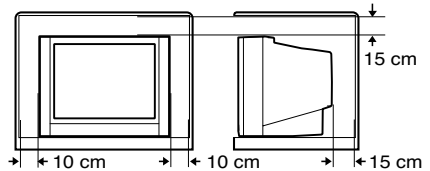

< AV-21V531/AV-29V531 >

The Twin Port Bass Blaster Unit is packaged together with the TV.  
Before you use the TV, mount the Twin Port Bass Blaster Unit correctly on the TV.

# Preparation

## 1 Confirm which remote control you have

Your TV comes with one of the three remote controls shown below. Functions you can operate differ depending on the type of remote control.

### <RM-C1303>

For TV model:  
AV-21V511  
AV-29V511

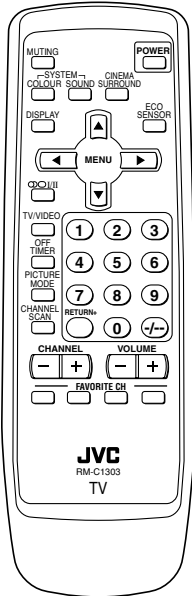

### <RM-C1305>

For TV model:  
AV-21V311  
AV-29V311

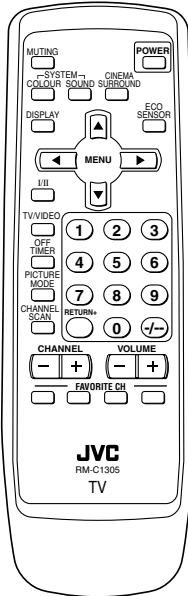

### <RM-C1307>

For TV model:  
AV-21V531  
AV-29V531

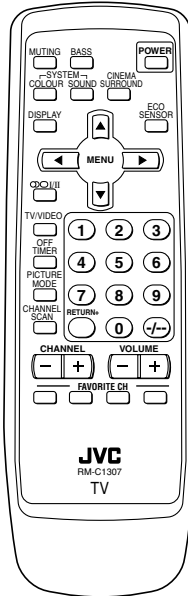

## 2 Insert the batteries into the remote control

Correctly insert two batteries, observing the ⊕ and ⊖ polarities and inserting the ⊖ end first.

### CAUTION:

Follow the cautions printed on the batteries.

### Notes:

- Use AA/R6/UM-3 dry cell batteries.
- If the remote control does not work properly, fit new batteries.  
The supplied batteries are for testing, not regular use.

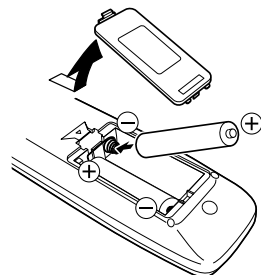

## Preparation

### 3 Connecting the aerial and VCR

- Read the manuals provided with the devices. Depending on the device, the connection method may be different from the diagrams. Also the device settings may need to change depending on the connection method.
- Turn off all the devices including the TV.
- Connecting cables are not supplied.
- When connecting monaural audio to the TV, use the L/MONO jack.
- You can connect an S-VIDEO compatible device (such as an S-VHS VCR) to the S-connector with an S-VIDEO cable and enjoy the high quality picture of the S-VIDEO signal (Y/C signal). In that case, do not connect it to the TV with a video cable.
- If you connect the VCR to the TV only with an aerial cable, you should preset the video channel from the VCR to the AV channel (channel number 0) on this TV. See “MANUAL CH PRESET” on page 16 and preset it manually.

#### Connecting the aerial

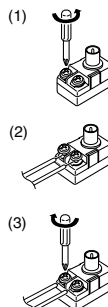
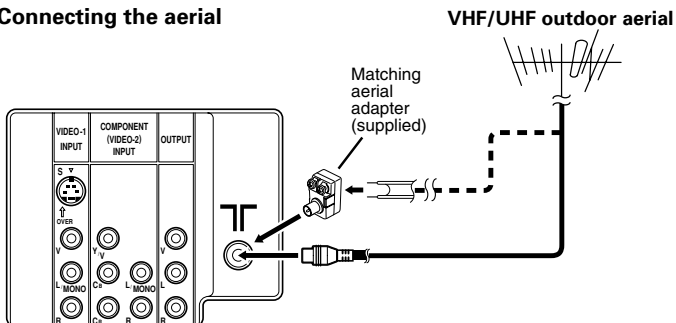

#### Connecting the aerial and VCR

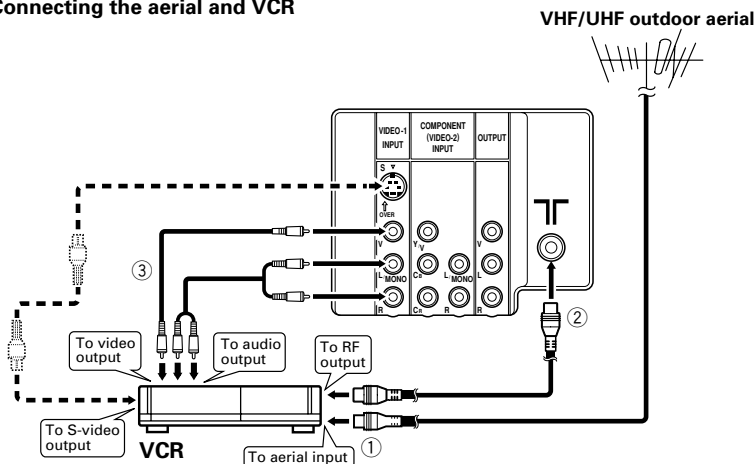

## Preparation

### 4 Connecting other devices

If you are not connecting any other devices, skip step 4 and perform step 5.

- Use the headphones with a stereo mini jack (3.5 mm in diameter). When you connect the headphones, the TV speakers go off.
- The OUTPUT terminal outputs the video and sound signals which you are viewing on the TV. You can dub them onto the VCR connected to the OUTPUT terminal. (The OUTPUT terminal cannot output S-VIDEO signals or component video signals. Also it cannot output any signals when the TV is turned off.)
- Connect components outputting a component signal (Y/C<sub>B</sub>/C<sub>R</sub> signal), such as a DVD player, to the VIDEO-2 terminal, and set VIDEO-2 SET function to “COMPONENT”. (See page 15.)
- The following illustrations are for the AV-21V311/AV-21V511/AV-21V531. Your TV’s front and rear panels may not look exactly like the illustrations.

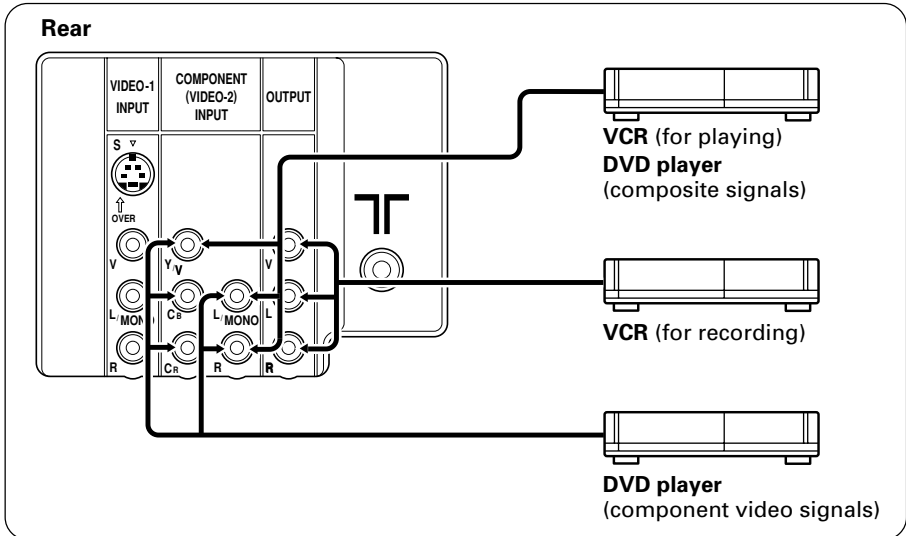
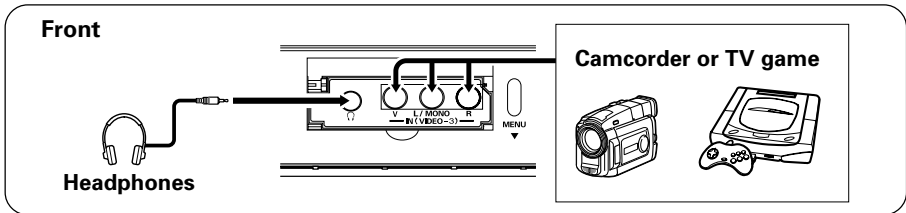

### 5 Connect the power cord to the AC outlet

Operate only from the power source indicated on the rear of the TV.

# Preparation

## 6 SETUP TOUR

When the TV is first turned on, it enters the SETUP TOUR mode, and the JVC logo is displayed. Follow the instructions on the on-screen display to perform the SETUP TOUR.

- In case of resetting that the reason for such as removal, you can set the AUTO CH PRESET function on the "MENU 3" menu. For details, see page 15.

### 1 Press the Main power button on the TV.

The POWER lamp lights. After the JVC logo has been displayed, the TV automatically switches to the language setting mode.



### 2 Press the CHANNEL +/- or the MENU </> buttons to select the on-screen language.

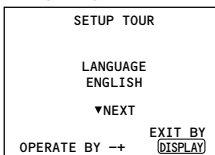

### 3 The AUTO PROGRAMMING function will start and the indicator blinks.

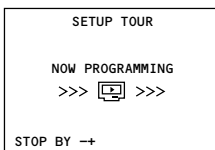

- To stop the AUTO PROGRAMMING function, press the CHANNEL +/- or the MENU </> buttons.

When all the TV channels that can be received on your TV have been preset, the display goes out and the AUTO PROGRAMMING function operation is completed.

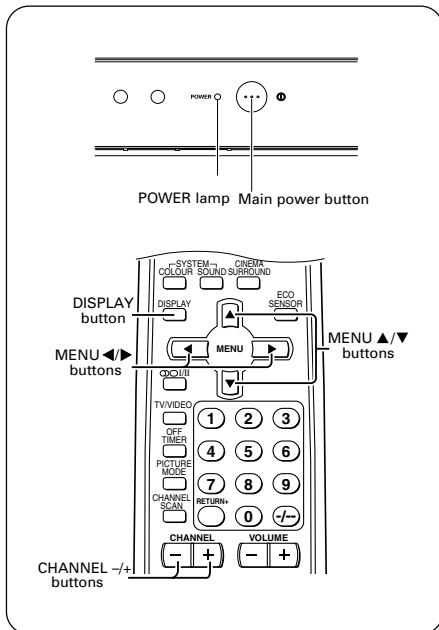

- If a TV channel you want to view is not set to the channel, set it with the MANUAL CH PRESET function. For details, see page 16.

### 4 Upon the completion of AUTO PROGRAMMING function, the message below is displayed.

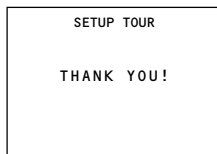

# Basic operation

The illustration below is for the remote control unit RM-C1307. Your remote control may not look exactly like the illustration.

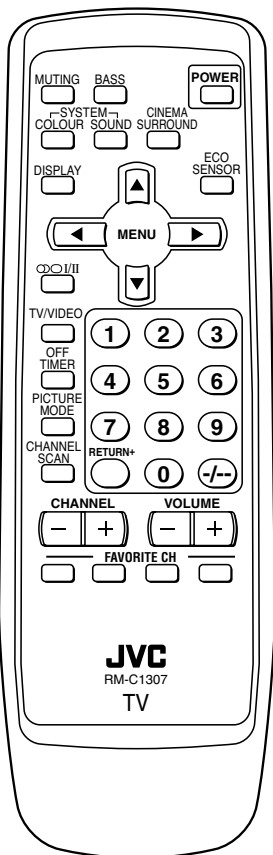

## 1 Press the POWER button to turn your TV on.

- If your TV does not turn on, press the Main power button on the TV, then press the POWER button again.
- You can also turn on your TV by pressing any of the following buttons;
  - the CHANNEL  $-/+$  button
  - the Number buttons
  - the TV/VIDEO button

## 2 Select a channel.

- Press the CHANNEL  $-/+$  button.
  - Up/down selection cannot be selected for channels to which the SKIP has been set to "YES". See page 17.
- Press the Number buttons to enter the channel number.
  - If you want to enter a two-digit number, press the  $-/--$  button to select the two digit mode "--", then enter the channel number.

## 3 Press the VOLUME $-/+$ button to adjust the sound.

## 4 To turn your TV off, press the POWER button.

- We recommend that you press the Main power button on the TV to turn the main power off if you do not plan to use your TV for a long time or if you wish to save energy.

### If the picture is not clear:

Press the COLOUR SYSTEM button to select another colour system, see page 8.

### If the sound is not clear:

Press the SOUND SYSTEM button to select another sound system, see page 8.

### Viewing Images from an External Device:

Press the TV/VIDEO button to select the VIDEO mode.

- You can also use the INPUT function to select the VIDEO mode. For details, refer to page 13.

# Remote control buttons and functions

## MUTING button

You can turn the sound off instantly.

**Press this button.**

To turn the sound on, press this button again.

## BASS button

< AV-21V531/AV-29V531 only >

You can enjoy a powerful bass sound by using the BASS (Bass Reflex) function.

**Press this button to turn the BASS function on or off.**

- To use this function, you must first mount the Twin Port Bass Blaster Unit packaged with the TV on top of the TV. For details, see page 20.

## SOUND SYSTEM button

If the sound is not clear even when the picture appears normal, change the current sound system to another sound system.

**Press this button to select the sound system.**

< AV-21V311/AV-29V311 only >

B/G

< Other models >

→ B/G → I → D/K → M

- You cannot select any sound system when in a VIDEO mode.

## COLOUR SYSTEM button

If the picture is not clear or no colour appears, change the current colour system to another colour system.

**Press this button to select the colour system.**

**In TV mode:**

< AV-21V311/AV-29V311 only >

→ AUTO → PAL → SECAM

< Other models >

→ AUTO → PAL → SECAM  
NTSC4.43 ← NTSC3.58 ←

**In VIDEO mode:**

→ AUTO → PAL → SECAM  
NTSC4.43 ← NTSC3.58 ←

**AUTO:**

Automatic colour system selection.

- If the picture is not normal in the AUTO mode, change the AUTO mode to another colour system.

## DISPLAY button

You can continuously display the current channel number or VIDEO mode on the screen.

**Press this button.**

To turn the display off, press this button again.

- When selecting a VIDEO mode with no signal, indication of the VIDEO mode becomes fixed on the screen.



## Remote control buttons and functions

---

### **CINEMA SURROUND button**

You can enjoy an enhanced sound for a wider audience by using CINEMA SURROUND function.

**Press this button to select one of the CINEMA SURROUND mode.**

#### **HIGH/LOW:**

When you listen to the stereo sound, please select HIGH mode or LOW mode. You can enjoy the sound for a wider audience similar to the experience at the theatre.

- In case that you setting up the CINEMA SURROUND function to HIGH mode, there may be slight volume distortion. In case that occurs, please switch the HIGH mode to LOW mode, the effect of CINEMA SURROUND functions will be less noticeable, however, the volume distortion will be corrected.

#### **MONO SURROUND:**

Select the MONO SURROUND mode, when you listen to the mono sound. You can enjoy the sound for a wider audience similar to stereo sound.

#### **OFF:**

The CINEMA SURROUND function switches off.

### **ECO SENSOR button**

You can adjust this TV so that the screen automatically adjusts to the optimum contrast according to the brightness of your room. This function reduces eye strain and the power consumption of this TV.

**Press this button to select the desired mode.**

#### **AI ECO SENSOR 1:**

The AI ECO SENSOR function switches on.

Usually, it is recommended to watch the TV in this mode.

#### **AI ECO SENSOR 2:**

The AI ECO SENSOR function switches on.

If you feel the screen in the “AI ECO SENSOR 1” mode is too dark, select this mode.

#### **AI ECO SENSOR OFF:**

The AI ECO SENSOR function switches off.

- You can display on the screen the effect of the AI ECO SENSOR function. For details, see “AI ECO DISPLAY” on page 19.

## Remote control buttons and functions

---

### ⊞⊞/II button

---

< AV-21V511/AV-21V531/AV-29V511/  
AV-29V531 only >

You can select a sound setting for stereo broadcast programmes and bilingual programmes.

**Press this button to select a sound setting.**

- ⊞⊞ : Stereo sound
- I : Bilingual I (sub I) sound
- II : Bilingual II (sub II) sound
- : Monaural sound

**MONO:** Cancels the multi-sound function, and the sound becomes monaural.

- If you have poor reception of a stereo broadcast, you can change from stereo sound (⊞⊞) to monaural sound (○) so that you can hear the broadcast more clearly and easily.
- If the multi-sound function cannot work normally due to poor signal quality, noise may be included in the sound, or the sound may change many times. If this happens, change the sound setting to MONO mode to cancel the multi-sound function.

### PICTURE MODE button

---

You can select one of three picture adjustment settings as you like.

**Press this button to select a mode.**

**BRIGHT:**

Heightens contrast and sharpness.

**STANDARD:**

Standardizes picture adjustments.

**SOFT:**

Softens contrast and sharpness.

- Pressing this button returns all the picture settings in "MENU 4" to their default settings.

### I/II button

---

< AV-21V311/AV-29V311 only >

You can select one of the two bilingual sounds in an A2 Sound-multiplex programme's bilingual programme.

**Press this button to select a bilingual sound.**

I : Bilingual I sound

II : Bilingual II sound

- The A2 Bilingual function has no effect on stereo programmes of the A2 Sound-multiplex broadcast programme type, although an A2 Bilingual function indicator will appear on the screen.
- The A2 Bilingual function has no effect on programmes other than A2 Sound-multiplex broadcast programme type, although an A2 Bilingual function indicator will appear on the screen.
- The A2 Bilingual function has no effect in VIDEO mode, although an A2 Bilingual function indicator will appear on the screen.

### OFF TIMER button

---

You can set the TV to automatically turn off after a set time.

**Press this button to select the period of time.**

- You can set the period of time to a maximum of 120 minutes in 10 minute increments.
- 1 minute before the OFF TIMER function turns off the TV, "GOOD NIGHT!" appears.

To display the remaining time, press this button once.

To cancel the OFF TIMER function, press this button to set the period of time to "0".

- The OFF TIMER function will not turn off the TV's main power.

## Remote control buttons and functions

---

### CHANNEL SCAN button

---

You can quickly view all TV channels programmes that you can view on your TV, and search for the programme you want to view.

#### 1 Press this button to start scanning TV channels.

The TV channel programmes are each displayed for several seconds.

- The programmes of TV channels for which the SKIP function is set to "YES" are not displayed.

#### 2 When you find the programme you want to view, press this button again to stop scanning.

### FAVORITE CH button

---

You can correlate 4 channels out of 99 channels (PR01-PR99) with FAVORITE CH buttons RED, GREEN, YELLOW and BLUE.

When not in TEXT mode, press one of the FAVORITE CH buttons for more than 3 seconds to correlate currently watching channel. After the channel and button are correlated, you can directly select favorite channel by the correlated button.

- When MENU is displayed, FAVORITE CH cannot be correlated.
- Correlation of FAVORITE CH button and the channel cannot be reset even though the main power is turned off.

### RETURN + button

---

You can set a channel you frequently view to the Return Channel and you can view that channel at any time with one-touch.

#### To set the channel to the Return Channel:

##### 1 Select the channel you want to set to the Return Channel.

##### 2 Press this button and hold until the message "RETURN PLUS PROGRAMMED!" appears.

- When you turn off the TV, the Return Channel setting is canceled.

#### To view the Return Channel:

Press this button.

- You can view two channels (current channel and Return Channel) alternately by pressing this button.

#### To cancel the Return Channel setting:

Press this button and hold until the message "RETURN PLUS CANCELED!" appears.

#### If no channel is set to the Return Channel:

You can view the channel selected right before the current channel by pressing this button.

# Using the TV's menus

This TV has a number of functions you can operate using the menus. To use all your TV's functions fully, you need to understand how to use the menus.

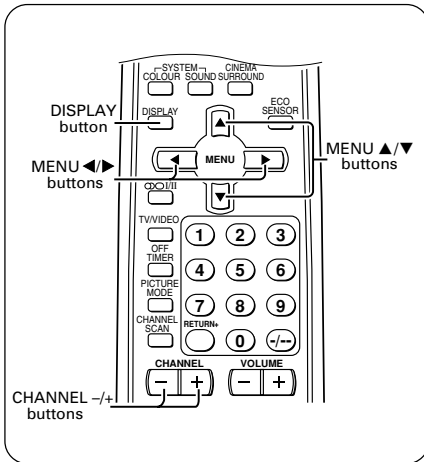

## 2 Repeatedly press the MENU ▲/▼ buttons to display a desired menu.

- If you hold down the ▼ button, the next menu is displayed.
- If the selected function is on the first line, pressing the ▲ button displays the preceding menu.

## 3 Repeatedly press the MENU ▲/▼ buttons to select a desired function.

## 4 Press the CHANNEL -/+ or the MENU ◀▶ buttons to change function settings.

Example:

Changes the AUTO SHUTOFF setting.

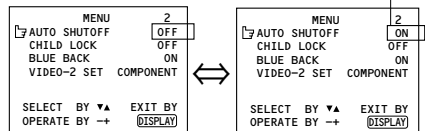



## Basic operation

### 1 Press the MENU ▲/▼ buttons.

One of the 6 menus is displayed.

MENU number

The icon  on the left indicates the currently selected function.

	MENU	1
	INPUT	TV
	VNR	ON
	COMPRESS(16:9)	ON
	PICTURE TILT	00
	SELECT BY ▼▲	EXIT BY
	OPERATE BY -+	

- With some functions, the operation method may differ.

## 5 Press the DISPLAY button to turn the display off.

- To operate a menu using the buttons on the front panel of the TV, refer to “Operating menus” on page 22.

# Using the TV's menus

## INPUT

You can view images from VCRs or other devices connected to your TV.

- 1 Press **MENU ▲/▼** to display the "MENU 1" menu, then select "INPUT".

MENU		1
INPUT	TV	
VNR	ON	
COMPRESS(16:9)	ON	
PICTURE TILT	00	
SELECT BY ▼▲		EXIT BY
OPERATE BY →←		<b>DISPLAY</b>

- 2 Press **CHANNEL -/+** or **MENU ◀/▶** to select "VIDEO-1", "VIDEO-2" or "VIDEO-3".

TV mode changes to VIDEO mode.

## PICTURE TILT

< AV-29V311/AV-29V511/AV-29V531 only >

There are cases where the Earth's magnetic force may make the picture tilt. If this happens, you can correct the picture tilt.

- 1 Press **MENU ▲/▼** to display the "MENU 1" menu, then select "PICTURE TILT".

MENU		1
INPUT	TV	
VNR	ON	
COMPRESS(16:9)	ON	
PICTURE TILT	00	
SELECT BY ▼▲		EXIT BY
OPERATE BY →←		<b>DISPLAY</b>

- 2 Continue pressing **CHANNEL -/+** or **MENU ◀/▶** until the picture becomes level.

## VNR

You can reduce picture noise.

- 1 Press **MENU ▲/▼** to display the "MENU 1" menu, then select "VNR".

MENU		1
INPUT	TV	
VNR	ON	
COMPRESS(16:9)	ON	
PICTURE TILT	00	
SELECT BY ▼▲		EXIT BY
OPERATE BY →←		<b>DISPLAY</b>

- 2 Press **CHANNEL -/+** or **MENU ◀/▶** to select "ON".

To cancel the VNR function, select "OFF".

## COMPRESS (16:9)

This function converts a normal picture (4:3 aspect ratio) into a wide picture (16:9 aspect ratio).

Use for pictures with a 16:9 aspect ratio that have been squeezed into a normal picture (4:3 aspect ratio), to restore their original dimensions.

- 1 Press **MENU ▲/▼** to display the "MENU 1" menu, then select "COMPRESS (16:9)".

MENU		1
INPUT	TV	
VNR	ON	
COMPRESS(16:9)	ON	
PICTURE TILT	00	
SELECT BY ▼▲		EXIT BY
OPERATE BY →←		<b>DISPLAY</b>

- 2 Press **CHANNEL -/+** or **MENU ◀/▶** to select "ON".

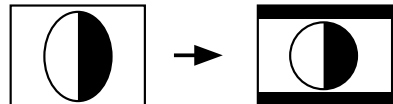

To cancel the COMPRESS (16:9) function, select "OFF".

# Using the TV's menus

---

## AUTO SHUTOFF

---

You can set your TV to turn off if no signals are received for about 15 minutes or longer after the end of a broadcast.

- 1 Press **MENU ▲/▼** to display the "MENU 2" menu, then select "AUTO SHUTOFF".

MENU	2
AUTO SHUTOFF	ON
CHILD LOCK	ON
BLUE BACK	ON
VIDEO-2 SET	COMPONENT
SELECT BY ▼▲	EXIT BY
OPERATE BY →	<b>[DISPLAY]</b>

- 2 Press **CHANNEL -/+** or **MENU ◀/▶** to select "ON".

To cancel the AUTO SHUTOFF function, select "OFF".

- The AUTO SHUTOFF function does not turn off the TV's main power.
- The AUTO SHUTOFF will not work for a VIDEO mode.

## CHILD LOCK

---

You can disable the front control buttons of the TV.

When this function is set to "ON", the TV can be operated using only the remote control.

Use this function to prevent children from operating the TV without parental consent.

- 1 Press **MENU ▲/▼** to display the "MENU 2" menu, then select "CHILD LOCK".

MENU	2
AUTO SHUTOFF	ON
CHILD LOCK	ON
BLUE BACK	ON
VIDEO-2 SET	COMPONENT
SELECT BY ▼▲	EXIT BY
OPERATE BY →	<b>[DISPLAY]</b>

- 2 Press **CHANNEL -/+** or **MENU ◀/▶** to select "ON".

To cancel the CHILD LOCK function, select "OFF".

- The CHILD LOCK function is canceled when you turn the power off.

## BLUE BACK

---

If no signal is being received or the signal is very weak, a blue screen automatically becomes the picture background.

If you wish to continue viewing the poor picture, you must set the BLUE BACK function to "OFF".

- 1 Press **MENU ▲/▼** to display the "MENU 2" menu, then select "BLUE BACK".

MENU	2
AUTO SHUTOFF	ON
CHILD LOCK	ON
BLUE BACK	ON
VIDEO-2 SET	COMPONENT
SELECT BY ▼▲	EXIT BY
OPERATE BY →	<b>[DISPLAY]</b>

- 2 Press **CHANNEL -/+** or **MENU ◀/▶** to select "ON".

To cancel the BLUE BACK function, select "OFF".

## Using the TV's menus

### VIDEO-2 SET

Set the VIDEO-2 SET correctly according to the video signal input from the external device connected to the VIDEO-2 terminal. If this setting is incorrect, images will not be displayed.

- 1 Press **MENU ▲/▼** to display the "MENU 2" menu, then select "VIDEO-2 SET".

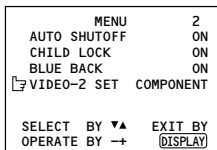

- 2 Set the VIDEO-2 SET according to the video signal input from the VIDEO-2 terminal.

**If a normal video signal (composite video signal) is input:**

Press the CHANNEL -/+ or the MENU ◀/▶ buttons to select "VIDEO".

**If a component video signal (Y/C<sub>B</sub>/C<sub>R</sub> signals) is input:**

Press the CHANNEL -/+ or the MENU ◀/▶ buttons to select "COMPONENT".

### LANGUAGE

You can select the language for the on-screen display.

- 1 Press **MENU ▲/▼** to display the "MENU 3" menu, then select "LANGUAGE".

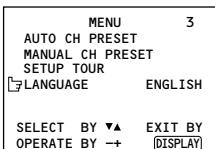

- 2 Press **CHANNEL -/+** or **MENU ◀/▶** to select language.

The on-screen display indications are in the selected language.

### AUTO CH PRESET

You can automatically preset all TV channels that can be received by your TV to channels.

- 1 Press **MENU ▲/▼** to display the "MENU 3" menu, then select "AUTO CH PRESET".

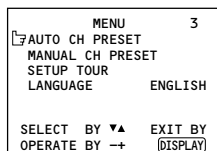

- 2 Press **CHANNEL -/+** or **MENU ◀/▶** to start the AUTO CH PRESET function.

">>> ON SEARCH" is displayed on the screen.

When all the TV channels that can be received on your TV have been preset, the display goes out and the AUTO CH PRESET function operation is completed.

**To stop the AUTO CH PRESET:**

Press the CHANNEL -/+ or the MENU ◀/▶ buttons.

- The AUTO CH PRESET function does not preset a TV channel to the AV channel (channel number 0).
- If the TV cannot preset the TV channel you want to view, preset it manually. For details, see "MANUAL CH PRESET" on page 16.

# Using the TV's menus

## MANUAL CH PRESET

You can manually preset desired TV channels to desired channels.

- 1 Press MENU ▲/▼ to display the "MENU 3" menu, then select "MANUAL CH PRESET".

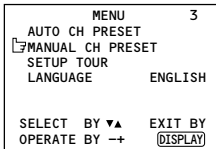

- 2 Press CHANNEL -/+ or MENU ◀/▶. The sub-menu is displayed.

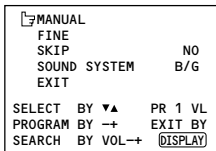

- The channel number is displayed as a PR number. For example, channel 1 will be displayed as PR 1. However, the AV channel will be displayed as AV.

- 3 Press CHANNEL -/+ or MENU ◀/▶ to select the channel number.
- 4 Press VOLUME -/+ to start searching for the TV channel.

">>>" or "<<<" is displayed on the screen.

When the TV finds a TV channel, the ">>>" or "<<<" display goes out, and the TV channel is preset to the currently selected channel number.

- If the TV channel you want to preset is not displayed, repeat step 4 until the TV finds the TV channel you want to preset.
- To stop the MANUAL CH PRESET function, press any button other than the VOLUME -/+ button.

If the picture is not clear:  
Fine-tune the TV channel.

- 1 Press MENU ▲/▼ to select "FINE".

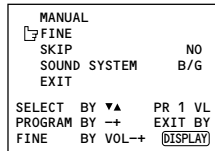

- 2 Hold VOLUME -/+ down to fine-tune the TV channel so that the best image is displayed on screen. ">" or "<" indicates that the TV is fine-tuning the TV channel.

If the sound is not clear:

- 1 Press MENU ▲/▼ to select "SOUND SYSTEM".

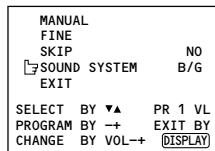

- 2 Press VOLUME -/+ to select the appropriate sound system.

- 5 Press MENU ▲/▼ to select "MANUAL".
- 6 Repeat steps 3 to 5 if you want to preset another TV channel to a channel.



## Using the TV's menus

### SKIP

You can set undesired channels to be skipped. Channels set to be skipped cannot be selected by the CHANNEL  $-/+$  buttons or the CHANNEL SCAN button.

- Channels to which TV channels have not been preset are automatically set to be skipped.

- 1 Press MENU  $\blacktriangle/\blacktriangledown$  to display the "MENU 3" menu, then select "MANUAL CH PRESET".
- 2 Press CHANNEL  $-/+$  or MENU  $\blacktriangle/\blacktriangledown$ .  
The sub-menu is displayed.
- 3 Press MENU  $\blacktriangle/\blacktriangledown$  to select "SKIP".

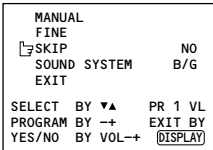

- 4 Press CHANNEL  $-/+$  or MENU  $\blacktriangle/\blacktriangledown$  to select the channel you want to skip.
- 5 Press VOLUME  $-/+$  to select "YES".  
The channel is set to be skipped. To cancel the SKIP function, select "NO".
- 6 Repeat steps 4 and 5 if you want to set another channel to skip.

### SETUP TOUR

You can start the SETUP TOUR function.

- 1 Press MENU  $\blacktriangle/\blacktriangledown$  to display the "MENU 3" menu, then select "SETUP TOUR".

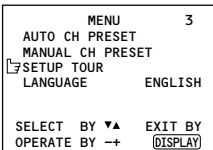

- 2 Press CHANNEL  $-/+$  or MENU  $\blacktriangle/\blacktriangledown$ .  
JVC logo appears and the SETUP TOUR function will start.  
For details, see page 6.

### Picture Adjustments

You can adjust the picture as you like.

- 1 Press MENU  $\blacktriangle/\blacktriangledown$  to display the "MENU 4" menu.

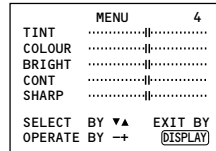

- 2 Press MENU  $\blacktriangle/\blacktriangledown$  to select an item and press CHANNEL  $-/+$  or MENU  $\blacktriangle/\blacktriangledown$  to adjust it.

TINT*	- : Reddish	+ : Greenish
COLOUR	- : Lighter	+ : Deeper
BRIGHT	- : Darker	+ : Brighter
CONT	- : Lower	+ : Higher
SHARP	- : Softer	+ : Sharper

\* TINT (tint) is displayed only when viewing images from NTSC3.58 or NTSC4.43 colour systems.

### Sound Adjustments

You can adjust the sound as you like.

- 1 Press MENU  $\blacktriangle/\blacktriangledown$  to display the "MENU 5" menu.

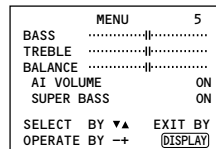

- 2 Press MENU  $\blacktriangle/\blacktriangledown$  to select an item and press CHANNEL  $-/+$  or MENU  $\blacktriangle/\blacktriangledown$  to adjust it.

BASS	- : Weaker	+ : Stronger
TREBLE	- : Weaker	+ : Stronger
BALANCE	- : Left	+ : Right

# Using the TV's menus

## AI VOLUME

You can prevent the sudden increase or decrease of volume that occurs when changing channels or switching VIDEO modes.

- 1 Press **MENU ▲/▼** to display the "MENU 5" menu, then select "AI VOLUME".

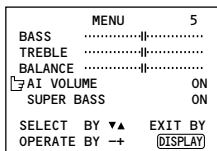

- 2 Press **CHANNEL -/+** or **MENU ◀/▶** to select "ON".

To cancel the AI VOLUME function, select "OFF".

- The AI VOLUME function may not operate as expected if the sound input level from a broadcast station (or video software) is extremely low.
- The AI VOLUME function for TV mode and VIDEO mode can be set separately. For example, you can set it to be off in TV mode and on in VIDEO mode. If you set the AI VOLUME function while viewing a TV channel, the setting is registered as the setting for TV mode. If you set the AI VOLUME function while viewing images from a VIDEO terminal, the setting is registered as the setting for VIDEO mode.

## SUPER BASS

You can enjoy a powerful bass sound by using the SUPER BASS (Bass Reflex) function.

- 1 Press **MENU ▲/▼** to display the "MENU 5" menu, then select "SUPER BASS".

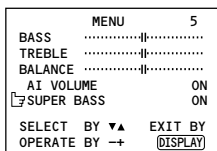

- 2 Press **CHANNEL -/+** or **MENU ◀/▶** to select "ON".

To cancel the SUPER BASS function, select "OFF".

## FAVORITE CH SETTING

You can set PICTURE MODE, VNR and PICTURE EFFECT functions for the favorite channels using FAVORITE CH SETTING menu.

- 1 Press **MENU ▲/▼** to display the "MENU 6" menu, then select "FAVORITE CH SETTING".

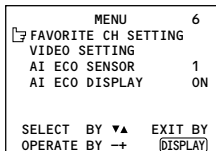

- 2 Press **CHANNEL -/+** or **MENU ◀/▶**.

The sub-menu is displayed.

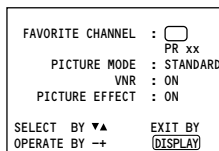

- 3 Press **CHANNEL -/+** or **MENU ◀/▶** to select one of the colours of "RED", "GREEN", "YELLOW" or "BLUE" assigned to FAVORITE CH button.

- 4 Press **MENU ▲/▼** to select "PICTURE MODE", then press **CHANNEL -/+** or **MENU ◀/▶** to select the picture mode of "BRIGHT", "STANDARD" or "SOFT".

- 5 Press **MENU ▲/▼** to select "VNR", then press **CHANNEL -/+** or **MENU ◀/▶** to select VNR "ON" or "OFF".

- 6 Press **MENU ▲/▼** to select "PICTURE EFFECT", then press **CHANNEL -/+** or **MENU ◀/▶** to select PICTURE EFFECT "ON" or "OFF".

- PICTURE MODE and VNR settings are changed only when you press the FAVORITE CH button while PICTURE EFFECT is ON. Otherwise, PICTURE MODE and VNR are not changed.

# Using the TV's menus

## VIDEO SETTING

You can set PICTURE MODE, VNR and PICTURE EFFECT functions for VIDEO mode using VIDEO SETTING menu.

- 1 Press MENU ▲/▼ to display the "MENU 6" menu, then select "VIDEO SETTING".

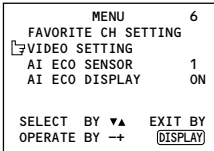

- 2 Press CHANNEL -/+ or MENU ◀/▶. The sub-menu is displayed.

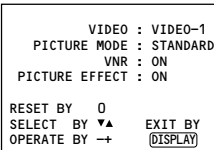

- 3 Press CHANNEL -/+ or MENU ◀/▶ to select "VIDEO-1", "VIDEO-2" or "VIDEO-3".
- 4 Press MENU ▲/▼ to select "PICTURE MODE", then press CHANNEL -/+ or MENU ◀/▶ to select the picture mode of "BRIGHT", "STANDARD" or "SOFT".
- 5 Press MENU ▲/▼ to select "VNR", then press CHANNEL -/+ or MENU ◀/▶ to select VNR "ON" or "OFF".
- 6 Press MENU ▲/▼ to select "PICTURE EFFECT", then press CHANNEL -/+ or MENU ◀/▶ to select PICTURE EFFECT "ON" or "OFF".
  - PICTURE MODE and VNR settings are changed only when VIDEO input mode is selected while PICTURE EFFECT is ON. Otherwise, PICTURE MODE and VNR are not changed.
  - Press 0 button to reset the setting.

## AI ECO SENSOR

You can enable this function so that the brightness of TV screen is automatically adjusted according to the brightness of your room.

- 1 Press MENU ▲/▼ to display the "MENU 6" menu, then select "AI ECO SENSOR".

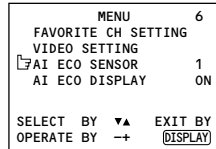

- 2 Press CHANNEL -/+ or MENU ◀/▶ to select "OFF", "1" or "2".

- For detailed description, see the "ECO SENSOR button" on page 9.

## AI ECO DISPLAY

You can display on the screen the effect of the AI ECO SENSOR function.

- 1 Press MENU ▲/▼ to display the "MENU 6" menu, then select "AI ECO DISPLAY".

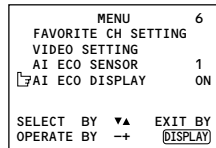

- 2 Press CHANNEL -/+ or MENU ◀/▶ to select "ON".

The clover mark indicating the brightness of your room is displayed for several seconds each time the brightness changes. The number of clover marks displayed on screen increases as your room becomes darker.

To cancel the AI ECO DISPLAY function, select "OFF".

# Attaching the Twin Port Bass Blaster Unit

< AV-21V531/AV-29V531 only >

The Twin Port Bass Blaster Unit is packaged together with the TV. Before you use the TV, mount the Twin Port Bass Blaster unit correctly on the TV.

## Note:

- The BASS functions do not work unless the Twin Port Bass Blaster Unit is connected correctly to the TV. For details on the BASS functions, see page 8.

## CAUTION:

- The Twin Port Bass Blaster Unit is just placed on top of the TV and is not held in place by a screw. When using the unit, pay attention to the following cautions. Otherwise, the unit or TV may fall over and be damaged, or cause unexpected injury.
  - Do not rest your hands or elbows on the Twin Port Bass Blaster Unit.
  - Do not move the TV with the Twin Port Bass Blaster Unit mounted on top of the TV. Before you move the TV, be sure to remove the unit.
  - Do not move the TV by holding the Twin Port Bass Blaster Unit.

- 1 Place the unit on top of the TV making sure that the mounting pin on the bottom of the unit fits into the mounting hole on the top of the TV.**

- When you mount the unit, make sure that the mounting pin fits properly into the mounting hole. Otherwise, it may slide off the top of the TV. This may cause damage or cause unexpected injury.

- 2 Firmly insert the Twin Port Bass Blaster Unit connector into the BASS SPEAKER OUT terminal.**

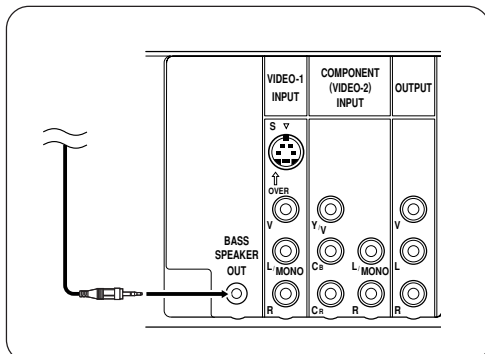
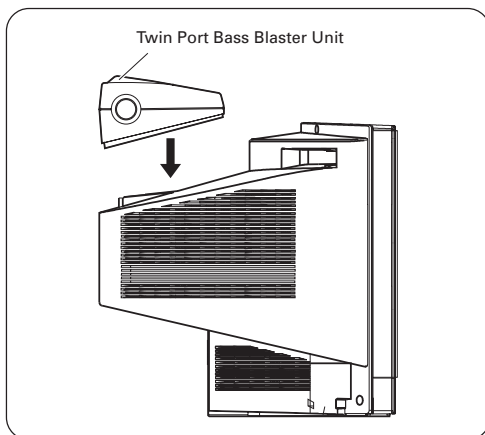

# TV buttons and parts

< AV-29V311/AV-29V511/AV-29V531 >

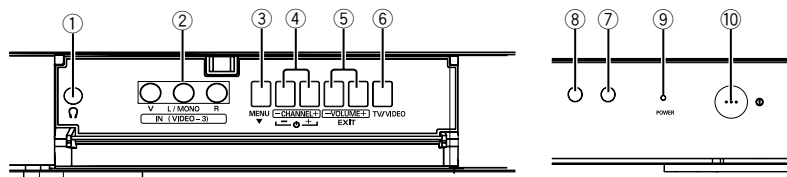

< AV-21V311/AV-21V511/AV-21V531 >

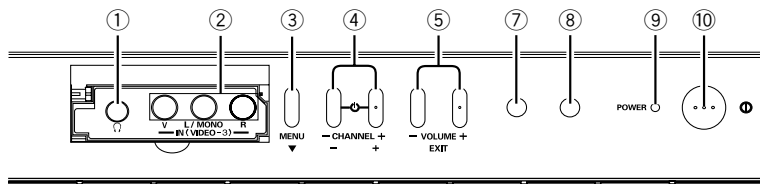

- |                       |                         |
|-----------------------|-------------------------|
| ① Headphone jack      | ⑥ TV/VIDEO button       |
| ② VIDEO-3 terminal    | ⑦ ECO sensor            |
| ③ MENU button         | ⑧ Remote control sensor |
| ④ CHANNEL -/+ buttons | ⑨ POWER lamp            |
| ⑤ VOLUME -/+ buttons  | ⑩ Main power button     |

# Using the buttons on the TV

---

## Basic operation

---

Check to make sure the CHILD LOCK function is set to "OFF". When the CHILD LOCK function is set to "ON", the TV cannot be operated using the front control buttons. For details, see "CHILD LOCK" on page 14.

- 1 Press CHANNEL  $-/+$  to turn the TV on from standby mode.
- 2 Press CHANNEL  $-/+$  to select a channel.
- 3 Press VOLUME  $-/+$  to adjust the volume.
- 4 To turn your TV off, press the Main power button to turn off the TV's main power.

### To change the TV mode to the VIDEO mode:

- Press the TV/VIDEO button if the TV has one. See page 7.
- If the TV has no TV/VIDEO button, select the VIDEO mode with the INPUT function in "MENU 1".

## Operating menus

---

You can operate function in menus using the front control buttons on the TV.

- 1 Press MENU  $\blacktriangledown$  to display a menu.
- 2 Press MENU  $\blacktriangledown$  repeatedly to display the menu you want to use.
- 3 Press MENU  $\blacktriangledown$  to select the desired function or item.
- 4 Press CHANNEL  $-/+$  or VOLUME  $-/+$  to carry out the desired operation.  
For details, see the description for each function.
- 5 Press VOLUME  $-/+$  to turn the menu display off.

### To turn the sub-menu display off:

- 1 Press MENU  $\blacktriangledown$  to select "EXIT".

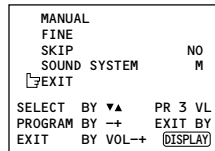

- 2 Press VOLUME  $-/+$  to turn the display off.

# Troubleshooting

---

If there is no picture or the TV does not operate normally, make sure the problem isn't due to the reasons indicated below.

If the problem persists even after taking the measures indicated, please contact a service technician.

## Cannot turn the TV on

- Press the Main power button on the TV.
- Connect the power cord to the AC outlet.

## The screen turns blue

- Is the BLUE BACK function on?  
(see page 14.)

## Remote control inoperable

- Replace the batteries. (see page 3.)

## Buttons on front of the TV do not work

- Switch the CHILD LOCK function off.  
(see page 14.)

## TV does not respond immediately

- Press the main power button on the TV to turn off the main power. Press the main power button again to turn on the TV. If the TV returns to a normal state, operation is normal.

## The TV turns off suddenly

- Is the OFF TIMER function set to operate?  
(see page 10.)
- Is the AUTO SHUTOFF function on?  
(see page 14.)

## Poor sound

- Press the SOUND SYSTEM button to select another sound system. (see page 8.)
- Adjust the sound settings. (see page 17.)
- If there is noise during mono sound output, press the  button to select "MONO". (see page 10.)

## Poor picture

- Press the COLOUR SYSTEM button to select another colour system. (see page 8.)
- Adjust the picture settings. (see page 17.)
- Is a component signal output device, such as a DVD player, connected correctly?  
(see page 5.)
- Is the VIDEO-2 SET function setting correct?  
(see page 15.)
- If noise (snow) totally blocks out the picture, check the following.
  - Have the TV and aerial been connected properly?
  - Has the aerial cable been damaged?
  - Is the aerial pointing in the right direction?
  - Is the aerial itself faulty?
- If the TV or aerial suffer interference from other equipment, stripes or noise may appear in the picture. Move any equipment which can cause interference away from the TV.
- If the TV or aerial suffer interference from signals reflecting from mountains or buildings, double-pictures (ghosting) will occur. Change the aerial's direction or replace it with an aerial with better directionality.
- When a white and bright still image (such as a white dress) is displayed on the screen, the white part may look as if it is coloured. When the image disappears from the screen, the unnatural colours will also disappear.

## The picture is tilted

< AV-29V311/AV-29V511/AV-29V531 only >

- A picture may be tilted due to the influence of the earth's magnetism. In this case, use the PICTURE TILT function to adjust the tilt. (see page 13.)

# Specifications

Model	AV-21V311	AV-21V511	AV-21V531	AV-29V311	AV-29V511	AV-29V531
<b>TV RF systems</b>	B, G	B, G, I, D, K, M		B, G	B, G, I, D, K, M	
<b>Colour systems</b>	PAL, SECAM	PAL, SECAM, NTSC 3.58 MHz, NTSC 4.43 MHz		PAL, SECAM	PAL, SECAM, NTSC 3.58 MHz, NTSC 4.43 MHz	
<b>Channel and frequencies</b>	VHF low channel (VL) = 46.25 to 168.25 MHz VHF high channel (VH) = 175.25 to 463.25 MHz UHF channel (U) = 471.25 to 863.25 MHz • Receives cable channels in mid band (X to Z, S1 to S10), super band (S11 to S20) and hyper band (S21 to S41).					
<b>Power input</b>	AC 110 to 240 V, 50/60 Hz (operating AC 90 to 260 V, 50/60 Hz)					
<b>Power consumption</b>	MAX 126 W AVG 81 W	MAX 126 W AVG 81 W	MAX 150W AVG 93 W	MAX 190 W AVG 145 W	MAX 190W AVG 145 W	MAX 212 W AVG 145 W
<b>Screen size (measured diagonally)</b>	Picture tube 549 mm Visible area 508 mm	Picture tube 549 mm Visible area 508 mm	Picture tube 549 mm Visible area 508 mm	Picture tube 728 mm Visible area 676 mm	Picture tube 728 mm Visible area 676 mm	Picture tube 728 mm Visible area 676 mm
<b>Audio output (Rated power output)</b>	7W + 7W	7W + 7W	7W + 7W +13W	10W + 10W	10W + 10W	7W + 7W +13W
<b>Speakers</b>	(6.5 cm x 13 cm) x 2	(6.5 cm x 13 cm) x 2	(6.5 cm x 13 cm) x 2 13 cm round x 1	(6.5 cm x 13 cm) x 2	(6.5 cm x 13 cm) x 2	(6.5 cm x 13 cm) x 2 13 cm round x 1
<b>External input/output</b>	VIDEO-1: S-VIDEO input, VIDEO input, AUDIO L/R input VIDEO-2/COMPONENT: VIDEO input, AUDIO L/R input, COMPONENT VIDEO (Y/Cb/Cr) input VIDEO-3: VIDEO input, AUDIO L/R input OUTPUT: VIDEO output, AUDIO L/R output Headphone jack: stereo mini jack (3.5 mm diameter)					
<b>Dimension (WxHxD) (mm)</b>	649 x 465.5 x 473.5	649 x 465.5 x 473.5	649 x 478 x 473.5	812 x 584.2 x 520.5	812 x 584.2 x 520.5	812 x 584.2 x 520.5
<b>Weight</b>	24.5 kg	24.5 kg	25.9 kg	43.5 kg	43.5 kg	45.9 kg
<b>Accessories</b>	• Remote control unit: RM-C1305 x 1	• Remote control unit: RM-C1303 x 1	• Remote control unit: RM-C1307 x 1	• Remote control unit: RM-C1305 x 1	• Remote control unit: RM-C1303 x 1	• Remote control unit: RM-C1307 x 1
	AA/R6/UM-3 dry cell battery x 2 Matching aerial-adaptor x 1					

***Design and specifications subject to change without notice.***



## **JVC SALES & SERVICE (THAILAND) CO., LTD**

### **Head Office & Service Center**

10th Floor, Sino-Thai tower, 32/31 Asok Road, (Sukhumvit 21),  
Bangkok 10110

TEL: (02)-260-1249-51 FAX: (02)-260-1275 ~ 6

### **Service Center**

Soi Sukhumvit 26 Branch, 108 Sukhumvit 26 (Soi Aree), Klongtoan,  
Klongtoey, Bangkok 10110

TEL: (02)-204-3004-11 FAX: (02)-204-3033

### **Norhtern Regional Service Center**

3/11 Sam Lan Road (Nha Wat Prasing), Tambol Prasing,  
Amphur Muang, Chiang Mai 50000

TEL: (053)-281-441 ~ 2 FAX: (053)-814-547

<http://www.jvc.co.th>

E-mail : [info@jvc.co.th](mailto:info@jvc.co.th)

**JVC**  
VICTOR COMPANY OF JAPAN, LIMITED